



*December 2010*

# Product Specification

## Rugged Metal 2.5" SATA II MLC SSD

(Solid-State Disk with Fast Erase / Secure Erase function)

### – BON Series –

Doc-No: 100-R2SFDBON-02V0



*This document is for information use only and is **subject to change without prior notice**. APRO Co., Ltd. assumes no responsibility for any errors that may appear in this document, nor for incidental or consequential damages resulting from the furnishing, performance or use of this material. No part of this document may be reproduced, transmitted, transcribed, stored in a retrievable manner or translated into any language or computer language, in any form or by any means, electronic, mechanical, magnetic, optical, chemical, manual or otherwise, without the prior written consent of an officer of APRO Co., Ltd.*

*All parts of the APRO documentation are protected by copyright law and all rights are reserved.*

*APRO and the APRO logo are registered trademarks of APRO Co., Ltd.*

*Product names mentioned herein are for identification purposes only and may be trademarks and/or registered trademarks of their respective companies.*

*© 2010 APRO Corporation. All rights reserved.*

*Revision History*

<b>Revision</b>	<b>Description</b>	<b>Date</b>
1.0	Initial Release	2010/5/25
1.1	1. New Rugged Metal case release and Warranty period modified 2. Table 2 : Flash memory chips part no. updated 3. General correction	2010/7/13  2010/8/06
2.0	All Dual-controlled SSD information is deleted.	2010/12/2

# CONTENTS

<b>1. INTRODUCTION</b> .....	<b>- 1 -</b>
1.1. SCOPE .....	- 2 -
1.2. APPLICABLE DOCUMENTS .....	- 2 -
1.3. DEVICE FEATURES .....	- 2 -
<b>2. SPECIFICATION</b> .....	<b>- 3 -</b>
2.1. PRODUCT DEFINITION .....	- 3 -
2.2. INTERFACE DESCRIPTION .....	- 4 -
2.3. CHARACTERISTICS .....	- 4 -
2.3.1. SATA MODES .....	- 4 -
2.3.2. BURST READ/WRITE PERFORMANCE .....	- 4 -
2.3.3. SUSTAINED READ/WRITE PERFORMANCE .....	- 4 -
2.3.4. ACCESS TIME .....	- 4 -
2.3.5. SEEK TIME AND LATENCY TIME .....	- 4 -
2.3.6. MEMORY CAPACITY .....	- 5 -
2.3.7. POWER CONSUMPTION .....	- 5 -
2.3.8. ENDURANCE .....	- 5 -
2.3.9. PHYSICAL SPECIFICATIONS .....	- 7 -
2.3.10. LED INDICATOR .....	- 9 -
2.3.11. CONNECTOR INTERFACE .....	- 9 -
2.4. ENVIRONMENTAL SPECIFICATIONS .....	- 10 -
2.4.1. TEMPERATURE .....	- 10 -
2.4.2. ALTITUDE .....	- 10 -
2.4.3. RELATIVE HUMIDITY .....	- 10 -
2.4.4. SHOCK .....	- 11 -
2.4.5. VIBRATION .....	- 11 -
2.5. CONFORMAL COATING .....	- 11 -
<b>3. CONFIGURATION OF BON SERIES RUGGED METAL 2.5" SATA MLC SSD</b> .....	<b>- 12 -</b>
3.1. SECURE ERASE JUMPER .....	- 12 -
3.2. INTERFACE CONNECTORS .....	- 12 -
3.3. SUPPORTED ATA COMMANDS .....	- 12 -
3.4. VENDOR-SPECIFIC COMMANDS .....	- 14 -
3.4.1. SANITIZE .....	- 14 -
3.4.2. SECURITY ERASE FUNCTIONALITY .....	- 17 -

**Contents**

---

**3.4.3. S.M.A.R.T. FUNCTION (SELF-MONITORING, ANALYSIS, AND REPORTING TECHNOLOGY) ..... - 17 -**

**4. ELECTRICAL SPECIFICATION ..... - 21 -**

**4.1. DEVICE ELECTRICAL CHARACTERISTICS ..... - 21 -**

**5. FUNCTIONAL DESCRIPTION ..... - 22 -**

**5.1. IDENTIFY DEVICE INFORMATION DEFAULT VALUE ..... - 22 -**

**6. PROCEDURE OF FAST ERASE / SECURE ERASE ..... - 27 -**

**6.1 2.5" SATA SSD\_BON SERIES FAST ERASE INTRODUCTION ..... - 27 -**

**6.2 EXECUTING SANITIZE PROCEDURE DURING POWER INTERRUPTION ..... - 27 -**

**APPENDIX A. ORDERING INFORMATION ..... - 28 -**

**(1) PART NUMBER LIST ..... - 28 -**

**(2) PART NUMBER DECODER ..... - 29 -**

**APPENDIX B. LIMITED WARRANTY ..... - 30 -**

### **1. Introduction**

APRO Rugged Metal 2.5" SATA MLC SSD – BON Series provides high capacity flash memory Solid State Drive (SSD) that electrically complies with Serial ATA 2.6 (SATA) standard and support SATA Gen-II (3.0 GB/s) with high performance. The main used flash memories are Samsung MLC-NAND type flash memory chips. The available disk capacities are 8GB, 16GB, 32GB, 64GB, 128GB, and 256GB.

The operating temperature grade is optional for commercial level 0°C ~ 70°C and wide temperature level with special conformal coating supports -40°C ~ +85°C. The data transfer performance by sustained read is up to 178.3 MB/sec (Typ.).

The APRO Rugged Metal 2.5" SATA MLC SSD product provides a high level interface to the host computer. This interface allows a host computer to write commands to the 2.5" SATA SSD to read or write blocks of memory. Each sector is protected by a powerful 8 bits or 15 bits Error Correcting Code (ECC). APRO Rugged Metal 2.5" SATA MLC SSD BON Series intelligent controller manages interface protocols, data storage and retrieval as well as ECC, defect handling and diagnostics, power management and clock control.

APRO Rugged Metal 2.5" SATA MLC SSD – BON Series supports Fast Erase/Secure Erase which initiates by hardware design and software vendor commands. APRO's Fast Erase Procedure is one of Default Sanitize procedure in BON Series Secure Erase SSD Series. Fast Erase enables users to erase entire disk contents in a matter of second; 8GB SSD needs about 6 seconds, and 128GB needs about 60 seconds to run the fast erase procedure for whole disk completely. **Furthermore, BON Series Rugged Metal 2.5" SATA MLC SSD also support Secure Erase (Sanitizing procedures) include NSA Manual 130-2, USA-AF AFSSI 5020, DoD 5220.22-M and IREC (IRIG) 106 standards by different special firmware versions.**

### **1.1. Scope**

This document describes the features and specifications and installation guide of APRO Rugged Metal 2.5" SATA MLC SSD – BON Series. In the appendix, there provides order information and warranty policy for the most convenient reference.

### **1.2. Applicable Documents**

- Serial ATA: High-speed serialized AT attachment, revision 1.0a, & revision 2.6 Serial ATA working group
- Parallel ATA: compatible with ATA/ATAPI-7.

### **1.3. Device Features**

- Samsung MLC-NAND type flash technology
- In 2.5 inch SSD form-factor in 9.5 mm height rugged metal casing
- 8GB, 16GB, 32GB, 64GB, 128GB and 256GB capacity.
- SATA 7-pin (data) + 15-pin (power connector) host Interface
- Fast Erase/Secure Erase by Hardware jumper setting located on the front side of SSD (J1/Pin-1&Pin-2) and by Software Vendor Commands.
- **Support sanitizing procedures include NSA Manual 130-2, USA-AF AFSSI 5020, DoD 5220.22-M and IREC (IRIG) 106 standards by different special firmware versions.**
- Extremely rugged metal casing to endure harsh environments
- SATA interface complies with the SATA 1.0a and SATA 2.6 standard.
- SMART (Self-Monitoring, Analysis and Reporting Technology) function supported.
- Non-volatile memory and no moving parts
- Performance up to 178.3 MB/sec
- Automatic 8 bits or 15 bits error correction (ECC) and retry capabilities.
- +5 V  $\pm 10\%$  operation
- Shock : 1,500G, compliance to MIL-STD-810F
- Vibration : 15G, compliance to MIL-STD-810F
- Working well in critical environment
- Very high performance, very low power consumption
- Low weight, Noiseless

## 2. Specification

### 2.1. Product Definition

The APRO BON Series 2.5" MLC SSD is a non-volatile mass memory storage unit equipped with a SATA interface. The SSD, whose dimensions enable mounting in a standard 2.5" disk drive enclosure, **Figure 1** shows a block diagram of the used high tech Industrial SATA MLC SSD controller.

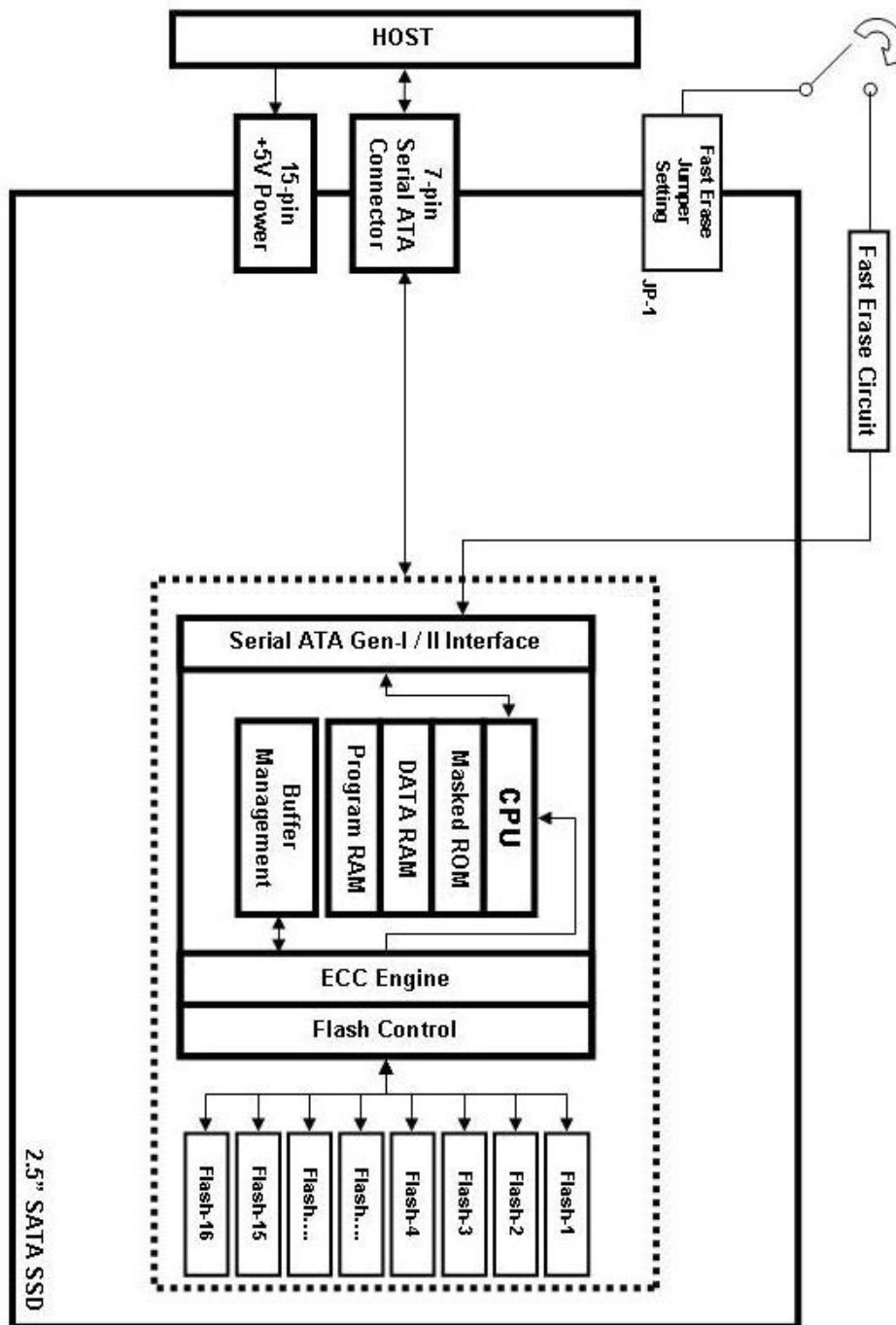

Figure 1: BON Series 2.5" SATA SSD block diagram

## **2.2. Interface Description**

The BON Series Industrial Rugged Metal 2.5" SSD's SATA interface complies with the SATA revision 1.0a and revision 2.6 standards. For specific details, refer to the applicable documents, as specified in Chapter 1.2.

## **2.3. Characteristics**

### **2.3.1. SATA Modes**

The BON Series Rugged Metal 2.5" SATA MLC SSD complies with the SATA revision 1.0a and revision 2.6 standards; and the data transfer rate complies with the following ATA modes (ATA/ATAPI-7)

- PIO mode 0, 1, 2, 3, 4
- MWDMA mode 0, 1, 2
- Ultra DMA mode 0, 1, 2, 3, 4, 5, 6

### **2.3.2. Burst Read/Write Performance**

The SSD burst read/write rate is 150 MB/sec (1.5 Gb/sec) by SATA Gen-1.0a and 300 MB/sec (3.0 Gb/sec) by SATA Gen-2.6.

### **2.3.3. Sustained Read/Write Performance**

**Table 1: Device Performances**

<b>Data Transfer Mode supporting</b>	<b>Serial ATA Gen-II (3.0Gb/s = 300MB/s)</b>					
<b>Capacity</b>	<b>8GB</b>	<b>16GB</b>	<b>32GB</b>	<b>64GB</b>	<b>128GB</b>	<b>256GB</b>
<b>Sequential Read (MB/s)</b>	92.4	167.4	167.8	167.8	167.8	152.5
<b>Sequential Write(MB/s)</b>	25.4	53.6	92.1	90	90	89
<b>The number of Flash IC</b>	8pcs	8pcs	8pcs	16pcs	16pcs	16pcs

Notes:

(1). All values quoted are typically at 25°C and nominal supply voltage.

(2). Testing of the Rugged Metal 2.5" SATA MLC SSD maximum performance was performed under the following platform:

- Computer with AMD 3.0GHz processor

- Windows XP Professional operating system

(3). All performance values are tested by APRO and for reference only. We don't guarantee customers' testing results are same as APRO's.

### **2.3.4. Access Time**

Average access time for the SSD is 0.1 ms (estimated)

### **2.3.5. Seek Time and Latency Time**

The SSD has no seek time or Latency time.

**2.3.6. Memory Capacity**

APRO Rugged Metal 2.5" SATA MLC SSD – BON Series are built-in mainly Samsung MLC -NAND Type Flash memory chips. The **Table 2** shows the equal part number of applied Samsung Flash memory chips for each card.

**Table 2: Card Configuration vs. Samsung NAND MLC part number**

<b>Card capacity</b>	<b>Samsung MLC flash memory part number * QTY</b>
<b>8GB</b>	K9G8G08U0A (8Gb) or equal * 8
<b>16GB</b>	K9GAG08U0M (16Gb) or equal * 8
<b>32GB</b>	K9LBG08U0M (32Gb) or equal * 8
<b>64GB</b>	K9LBG08U0M (32Gb) or equal * 16
<b>128GB</b>	K9HCG08U1M (64Gb) or equal * 16
<b>256GB</b>	K9MDG08U5M (128Gb) or equal * 16

**2.3.7. Power Consumption**

Input voltage of +5VDC, with a tolerance of 10% (4.5V-5.5V) and a maximum ripple of 250 mV peak-to-peak are required.

**Table 3** specifies the power consumption based on Capacity. The power consumptions are determined by the disk Capacity and the flash components being used.

**Table 3: Device Power Consumption**

<b>Unformatted Disk Capacity</b>	<b>Idle Mode</b>		<b>Reading Mode</b>		<b>Writing Mode</b>	
	<b>mA</b>	<b>W</b>	<b>mA</b>	<b>W</b>	<b>mA</b>	<b>W</b>
8GB -256GB Single Controlled	320	1.60	450	2.25	500	2.5

**2.3.8. Endurance**

- Un-limited Read Cycles

The SSD product life span and the performance are enhanced by the following features:

**2.3.8.1. Flash Management Technology - Static Wear Leveling**

In order to gain the best management for flash memory, APRO Rugged Metal 2.5" SATA MLC SSD – BON Series supports Static Wear leveling technology to manage the Flash system. The life of flash memory is limited; the management is to increase the life of the flash product.

A static wear-leveling algorithm evenly distributes data over an entire Flash cell array and searches for the least used physical blocks. The identified low cycled sectors are used to write the data to those locations. If blocks are empty, the write occurs normally. If blocks contain static data, it moves that data to a more heavily used location before it moves the newly written data. The static wear leveling maximizes effective endurance Flash array compared to no wear leveling or dynamic wear leveling.

**2.3.8.2. ECC Technology**

Please refer to **Figure 2** is a diagram illustrating an allocation method of a spare area in each page of a NAND flash memory, wherein the specific ECC algorithm utilizes a Bose, Chaudhuri and Hocquengham (BCH) ECC algorithm. When a BCH 8 ECC algorithm encodes the data in the NAND flash memory, the parity code generated in the encoding process may occupy 13 bytes of the spare area in each page. When a BCH 15 ECC algorithm encodes the data in the NAND flash memory, the parity code generated in the encoding process may occupy 25 bytes of the spare in each page. When a BCH 8 algorithm decodes the data in the NAND flash memory, the data can be decoded correctly if the error bit happened in one sector (512 Bytes) is 8. When a BCH 15 algorithm decodes the data in the NAND flash memory, the data can be decoded correctly if the error bit happened in one sector is 15.

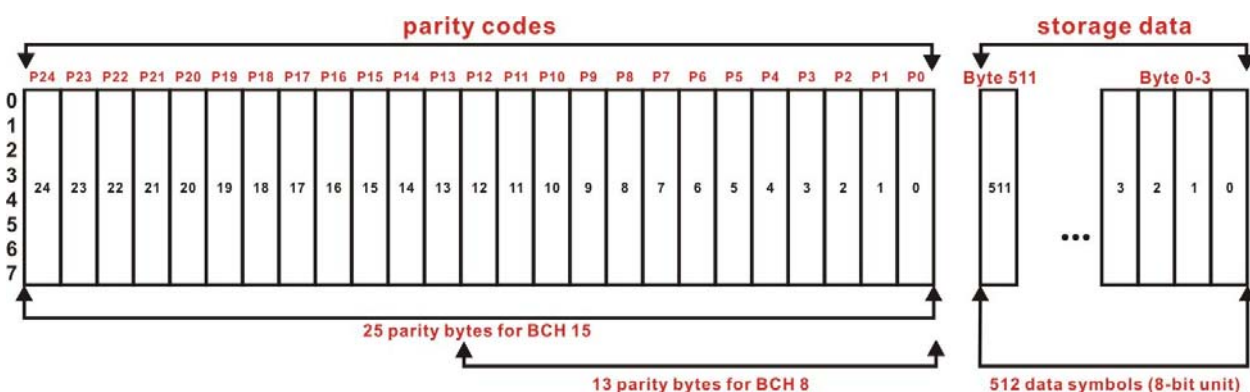

**Figure 2: Allocation for ECC Algorithm BCH in NAND Flash**

**2.3.8.3. Bad Block Management**

Bad blocks of NAND flash may accumulate up to 2% of entire number of blocks during its manufacturing process and during the flash operational usage.

A system must be able to recognize bad block(s) based on the original bad block information and create a bad block table to keep track of blocks that fail during use. The first block of NAND Flash (block 0) is guaranteed to be good. The bad block information is stored in the reservoir area that is located in the highest address region of the NAND flash. Once the bad blocks have been located, and the bad blocks be no longer accessed.

To locate the bad blocks on a brand new device, read out each block. Any block that is not all FFFFh in 1<sup>st</sup> sector of 1<sup>st</sup> or 2nd page in a spare area is a bad block. Although random bit errors may occur during use, this does not necessarily mean that a block is bad. Generally, a block should be marked as bad only when there is a problem or erase failure. This can be determined by doing a status read after erase/program operation. The flash memory is initialized by formatting the flash memory into a reserved area and user area.

## Product Specification

---

In order to detect the initial bad blocks to handle run time bad blocks, APRO BON Series' SSD provides the Bad Block Management scheme. It remaps a bad block to one of the reserved blocks so that the data contained in one bad block is not lost and new data writes on a bad block is avoided.

### 2.3.9. Physical Specifications

Refer to **Table 4** and see **Figure 3** for APRO Rugged Metal 2.5" SATA MLC SSD – BON Series physical dimensions and Fast Erase / Secure Erase hardware jumper setting (**optional hardware setting**) specification.

**Table 4: Device Physical Specifications**

<b>Capacity:</b>	<b>8GB to 256GB</b>
<b>Thickness:</b>	9.50 mm / 0.374 in
<b>Length:</b>	99.70 mm / 3.925 in
<b>Width:</b>	69.90 mm / 2.752 in
<b>Weight:</b>	115.00 g / 4.06 oz

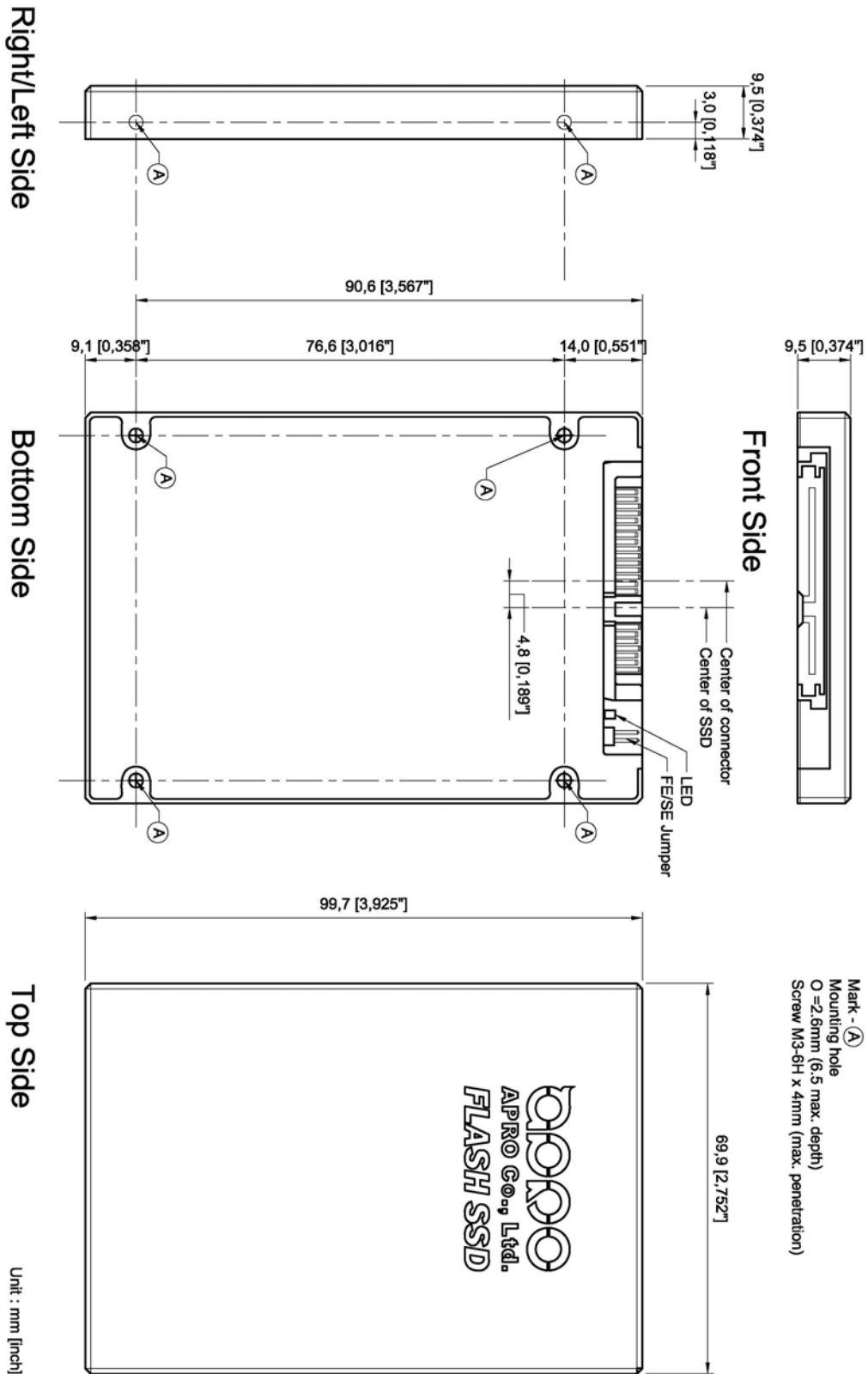

Figure 3: Device Dimension

**2.3.10. LED Indicator**

The SSD includes 3 LEDs, 1 green and 2 red, located on the front side of the SSD. These LEDs indicate the following, Refer to **Figure 4**:

1. Power (Green) LED: This is the SSD power indicator. When the power LED is lit, the SSD is receiving power.
2. Busy (Red) LED: This is the SSD busy indicator. When the busy LED is lit, the SSD is active.

**2.3.11. Connector Interface**

Refer to **Table 5** and see **Figure 4** for APRO Rugged Metal 2.5" SATA MLC SSD – BON Series pin assignments there are total of 7 pins in the signal segment and 15 pins in the power segment.

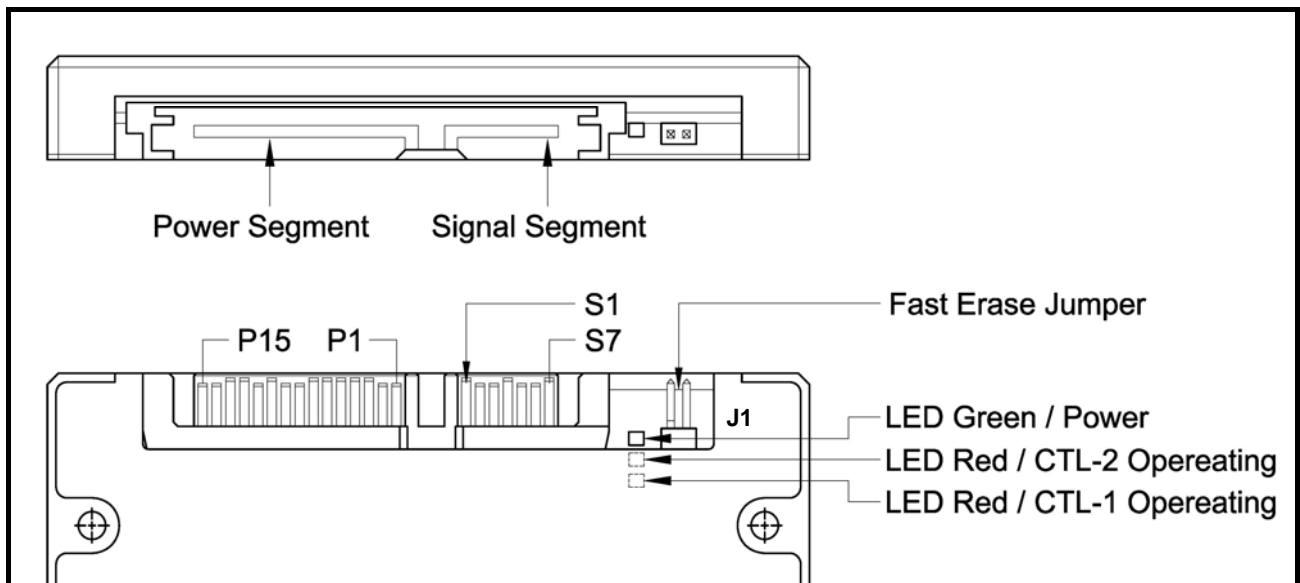

**Figure 4: Device – SATA Pins and LEDs Configuration**

**Table 5: Device Signal and Power Segment Pin Assignments**

Name	Type	Description
S1	GND	
S2	A+	Differential Signal Pair A
S3	A-	
S4	GND	
S5	B-	Differential Signal Pair B
S6	B+	
S7	GND	
<b>Key and Spacing separate signal and power segments</b>		
P1	V33	3.3V Power
P2	V33	3.3V Power
P3	V33	3.3V Power, Pre-charge
P4	GND	
P5	GND	
P6	GND	

## Product Specification

---

<b>P7</b>	V5	5V Power, Pre-Charge
<b>P8</b>	V5	5V Power
<b>P9</b>	V5	5V Power
<b>P10</b>	GND	
<b>P11</b>	DAS/DSS	Device Activity Signal / Disable Staggered Spin up
<b>P12</b>	GND	
<b>P13</b>	V12	12V Power, Pre-charge
<b>P14</b>	V12	12V Power
<b>P15</b>	V12	12V Power

Notes:

All pins are in a signal row with a 1.27 mm (0.050" pitch).

The commands on the mating sequence in forward table apply to the case of backplane blind mate connector only. In this case, the mating sequences are:

- (1) The pre-charge power pins and other ground pins.
- (2) The signal pins and the rest of the power pins.

### 2.4. Environmental Specifications

The SSD complies with the specified performance requirements after exposure to non-operating environmental conditions, or during and after exposure to operating environmental conditions.

#### 2.4.1. Temperature

##### 2.4.1.1. Operating

The SSD operates without degradation over the following ambient air temperature range (the maximal temperature change rate shall not exceed 5°C per minute):

- Commercial Grade : 0°C to +70°C
- Industrial Grade : -40°C to +85°C ( With special conformal coating treatment on PCBA )

##### 2.4.1.2. Non-Operating

The SSD complies with the specified performance requirements after exposure to the following conditions (the maximal temperature change rate may not exceed 5°C per minute):

- Commercial Grade : -20°C ~ +80°C
- Industrial Grade : -50°C ~ +95°C ( With special conformal coating treatment on PCBA )

#### 2.4.2. Altitude

The SSD is capable of full operation at altitudes from sea level to 70,000 feet above sea level, and can withstand air transportation in non-pressurized flights at altitudes of up to 70,000 feet above sea level.

#### 2.4.3. Relative Humidity

The SSD withstands 10% to 95% non-condensing relative humidity.

### **2.4.4. Shock**

The SSD operates without degradation when subjected to shock testing of 1500 G half-sine pulses of 0.5 ms. Shock analysis was performed compliant with standard MIL-STD-810F.

### **2.4.5. Vibration**

The SSD operates without degradation when subjected to the following vibration conditions:

- 15G RMS
- Random vibrations: 3 vibration axes, 10 Hz to 2000 Hz.

Vibration analysis was performed compliant with standard MIL-STD-810F.

## **2.5. Conformal coating**

Conformal coating is a protective, dielectric coating designed to conform to the surface of an assembled printed circuit board. Commonly used conformal coatings include silicone, acrylic, urethane and epoxy. APRO applies only silicone on APRO storages products upon requested especially by customers. The type of silicone coating features good thermal shock resistance due to flexibility. It is also easy to apply and repair. Conformal coating offers protection of circuitry from moisture, fungus, dust and corrosion caused by extreme environments. It also prevents damage from those Flash storages handling during construction, installation and use, and reduces mechanical stress on components and protects from thermal shock. The greatest advantage of conformal coating is to allow greater component density due to increased dielectric strength between conductors.

APRO uses MIL-I-46058C silicon conformal coating.

### 3. Configuration of BON Series Rugged Metal 2.5" SATA MLC SSD

#### 3.1. Secure Erase Jumper

When a jumper is placed between 2 of these headers (J1), the SSD erases the media immediately.

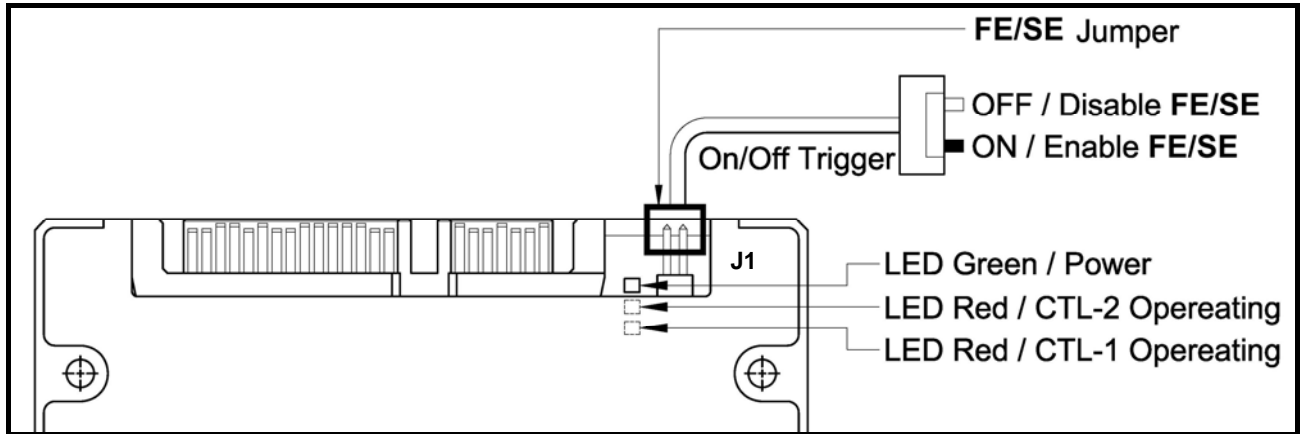

Figure 5: Secure Erase/Fast Erase Jumper Setting

#### 3.2. Interface Connectors

The SSD interface cable consists of four conductors in two differential pairs, plus three ground connections. There are total of 7 pins in the signal segment and 15 pins in the power segment. All pins are in a single row, with a 1.27 mm (0.050") pitch. See **Figure 5**.

#### 3.3. Supported ATA Commands

The commands supported ATA/ATAPI-7 commands; certain obsolesced commands are also supported. The supported commands are listed in **Table 6**.

Table 6: Device ATA Commands Supported

Command Name	Command Code (Hex)
CHECK POWER MODE	E5h
EXECUTE DIAGNOSTICS	90h
FLUSH CACHE	E7h
FLUSH CACHE EXT	EAh
IDENTIFY DEVICE	ECh
IDLE	E3h
IDLE IMMEDIATE	E1h
INITIALIZE DEVICE PARAMETERS	91h
READ BUFFER	E4H
READ DMA	C8h or C9h
READ DMA EXT	25h
READ FPDMA QUEUED	60h

**Product Specification**

<b>READ LOG EXT</b>	2Fh
<b>READ MULTIPLE</b>	C4h
<b>READ MULTIPLE EXT</b>	29h
<b>READ SECTOR(S)</b>	20h or 21h
<b>READ SECTOR(S) EXT</b>	24h
<b>READ VERIFY SECTOR(S)</b>	40h or 41h
<b>READ VERIFY SECTOR(S) EXT</b>	42h
<b>RECALIBRATE</b>	10h
<b>SET FEATURES</b>	EFh
<b>SECURITY DISABLE PASSWORD</b>	F6h
<b>SECURITY ERASE PREPARE</b>	F3h
<b>SECURITY ERASE UNIT</b>	F4h
<b>SECURITY FREEZE LOCK</b>	F5h
<b>SECURITY SET PASSWORD</b>	F1h
<b>SECURITY UNLOCK</b>	F2h
<b>SEEK</b>	7xh
<b>SET FEATURES</b>	EFh
<b>SET MULTIPLE MODE</b>	C6h
<b>SLEEP</b>	E6h
<b>SMART</b>	B0h
<b>STANDBY</b>	E2h
<b>STANDBY IMMEDIATE</b>	E0h
<b>SANITIZE (including fast secure erase)</b>	80h
<b>WRITE BUFFER</b>	E8h
<b>WRITE DMA</b>	CAh or CBh
<b>WRITE DMA EXT</b>	35h
<b>WRITE DMA FUA EXT</b>	3Dh
<b>WRITE FPDMA QUEUED</b>	61h
<b>WRITE MULTIPLE</b>	C5h
<b>WRITE MULTIPLE EXT</b>	39h
<b>WRITE MULTIPLE FUA EXT</b>	CEh
<b>WRITE SECTOR(S)</b>	30h or 31h
<b>WRITE SECTOR(S) EXT</b>	34h

### 3.4. Vendor-Specific Commands

#### 3.4.1. Sanitize

##### 3.4.1.1. Sanitize (Purge) Command Interface

Destruction (purging/declassifying) of the information on the media is enabled by the Sanitize command. Bad blocks accumulated since the unit was manufactured undergo the same process as good blocks. Using either the Sanitize command itself, or using the Sanitize Interrupt command can activate the default sanitize procedure.

The Sanitize command provides a high degree of flexibility, which enables executing declassification procedures defined in various standards by providing different arguments to the command. Specifically, defining up to three stages of the declassification process is also enabled by the Sanitize command parameters. Each stage can be either erasing the media and overwriting it with a given character, or erasing the media and filling it with random information a specified number of times.

If the number of erase-fill cycles is 0xFF, the Sanitize command performs a complete erase but does not fill the media. The Sanitize command is the fastest option; and is also known as the Security Erase option. The structure of the Security Erase command is described in **Table 7**.

**Table 7: Vendor-Specific Sanitize Command**

Register	7	6	5	4	3	2	1	0
Features	Secondary operation code							
Sector count	Master command							
Sector number	Parameter 1							
Cylinder low	Parameter 2							
Cylinder high	Parameter 3							
Device/Head	1		1	D	Partition Mask			
Command	80h							

##### 3.4.1.2. Compliance with Existing Sanitize (Purge) Standards

The interface specified in **Table 8** enables defining a wide range of Sanitize procedures.

**Table 8: Device Supported Sanitizing Procedures**

Operation	Master Command	Parameter		
		1	2	3
Execute the default Sanitize procedure.	0xff	0xff	0xff	0xff
Erase the media ( <b>Security Erase</b> ).	0x41	0xff	0xff	0xff

<b>NSA Manual 130-2</b> Erase the media and overwrite with random data 2 times, then erase and overwrite with a character.	0x81	0x02	Char	0x00
<b>USA-AF AFSSI 5020</b> Erase the media and overwrite with random data.	0x41	0x01	0x00	0x00
<b>DoD 5220.22-M</b> Erase the media and overwrite with single character, then erase again.	0x84	Char	0xff	0x00
<b>IREC (IRIG) 106</b> Erase the media, overwrite with 0x55, erase, overwrite with 0xAA, erase	0XD0	0x55	0xAA	0x00
Erase the media and overwrite with random data (different data each time) 21 times.	0x41	0x15	0x00	0x00
Erase the media and overwrite with random data (different data each time) 381 times.	0xD5	0x7F	0x7F	0x7F

*Notes:*

1. Before every overwrite process, all blocks are erased as per the flash specification.
2. Blocks subjected to the Sanitize procedure are all blocks not registered in the original manufacturer's Bad Block Table.

**3.4.1.3. Auto-Resume Sanitize Feature**

When Auto-Resume is enabled (the manufacturer's default setting), if a power interruption takes place during a Sanitize procedure the SSD re-launches the Sanitize procedure on the next power-up.

If the Sanitize Interrupt command is active during power-up, the Sanitize procedure that was initiated before the power interruption is completed by the unit first. If the Sanitize interrupt command is still active when the procedure is complete, the SSD restarts the default Sanitize procedure. Auto-Resume Sanitize Feature is described in **Table 8**.

**3.4.1.4. Random Data Written During the Sanitize Procedure**

The random data used to overwrite user data is a digest of pseudo-random generation and real random data. The pseudo-random generation is seeded in such a manner that even if the SSD launches the Sanitize command under identical external conditions (for example, if the unit is powered on with Sanitize Interrupt active), it will produce different seeds and different pseudo-random data.

**3.4.1.5. LED Activity During the Sanitize Procedure**

During the Format and Sanitize procedures, the red LED status indication as follows:

- Remains lit during the Erase phase (for the Sanitize procedure, during each erase phase)
- Blinks during the Media Fill phase (for the Sanitize procedure, during each fill phase)
- Remains lit for a short period while the disk achieves ready status after completing the Sanitize procedures.

### **3.4.1.6. Using the SSD After a Sanitize Procedure**

Performing a low-level format on the media is necessary if the fill option is non-activated (after completed Sanitize Procedures).

Failing to perform the low-level format may result in a longer start-up time.

### **3.4.1.7. Sanitizing Based on NSA Manual 130-2**

Sanitizing semiconductor memory devices procedure is clarified by the USA National Security Agency (NSA) specifies as in documents “130-2 Media Declassification” and “Destruction Manual” (Paragraph 5, Section 7) which indicates the procedure for sanitizing EEPROM at version November, 2000.

- “Overwriting all locations with a pseudo-random pattern twice”.
- “Overwriting all locations with a known pattern”.

The SSD complies with the above requirement, as described in **Table 8**.

### **3.4.1.8. Sanitizing Based on USA Air Force AFSSI 5020**

Sanitizing confidential media procedure is specified by the USA Air Force System Security Instruction (AFSSI) 5020, dated 20 August, 1996. Security procedure for all types of semiconductor media is elaborated in Chapter 5: Semiconductor Devices. The procedure for sanitizing flash memory is described in paragraph 5.3 as follows:

- “Pulsing the erase control gate and verifying the erasure”.
- “Overwrite all bit locations with arbitrary unclassified data”.

The SSD complies with the above requirement, as described in **Table 8**.

### **3.4.1.9. Sanitizing Based on DoD 5220.22-M**

The sanitization processed for each media type (in order to be considered declassified) is specified in Chapter 8, Automated Information System Security. The sanitize process for EPROM media type is as follows:

- “Overwrite all addressable location with a single character.”
- “Perform a full chip erase as per manufacturer’s data sheet.”

The SSD complies with the above requirement, as described in **Table 8**.

### **3.4.1.10. Declassification Based on IRIG-106 (NTISSP-9)**

The Telemetry Group (TG) of the Range Commanders Council (RCC) has prepared documents to foster the compatibility of telemetry transmitting, receiving, and signal processing equipment at the member ranges under the cognizance of the RCC.

IRIG (Inter-Range Instrumentation Group) 106 are set of Telemetry standards which provide the necessary criteria on which to base equipment design and modification.

The National Telecommunication & Information Security Systems (NTISSP-9) Chapter 10 describes the requirements for SOLID STATE RECORDER STANDARD. Section 10.8 (declassification) addresses declassification for various Solid-State Disks as follows:

- First Erase – Every memory block on the board is erased
- First write 0x55 – Every memory chip location is recorded with a pattern 0x55
- Second Erase – Every memory block on the board is erased
- Second write 0xAA – Every memory chip location is recorded with a pattern 0xAA
- Third Erase – Every memory block on the board is erased

APRO BON Series' SSD Sanitize feature complies with the above requirements as described in **Table 8**.

**3.4.2. Security Erase Functionality**

The Security Erase option enables quickly erasing all the data stored on the SSD. The SSD also supports the Fast Security Erase option, which is faster than the standard Security Erase option. This function is activated by the vendor-unique Sanitize command or via the Sanitize hardware interrupt triggered by the Secure Erase header (if available). To enable activating the Fast Security Erase option, please to study the **Appendix-A Hardware Fast Erase USER Manual**.

Typical power consumption during security erase depends on both the device Capacity and on the NAND flash type.

**Table 9** describes the specifications for Security Erase operations. The SSD input voltage is +5VDC, with a tolerance of 10% (4.5V-5.5V) and maximum ripple of 250 mV peak-to-peak.

**Table 9: Typical Power Consumption during Security Erase**

Disk Capacity	Power Consumption During Security Erase-Read (Maximum)		Power Consumption During Fast Security Erase-Write (Maximum)	
	mA	W	mA	W
8-256GB Single Controlled	500	2.50	550	2.75

**3.4.3. S.M.A.R.T. Function (Self-Monitoring, Analysis, and Reporting Technology)**

According to the subcommand specified in the Features register, performing different processing requires predicting device failures. If the Features register contains an unsupported value, the Aborted Command error is returned. If the SMART function is disabled, any subcommand other than SMART ENABLE OPERATIONS results in the Aborted Command error.

**3.4.3.1. S.M.A.R.T. Read Data**

**Table 10: SMART Feature registers values**

Value	Command
D0h	SMATR Read Data
D8h	SMART ENABLE OPERATIONS
D9h	SMART DISABLE OPERATIONS

**Table 11: SMART command for inputs information**

Register	7	6	5	4	3	2	1	0
Features	D0h							
Sector Count	Na							
LBA Low	Na							
LBA Mid	4Fh							
LBA High	C2h							
Device	Obs	Na	obs	DEV	Na	Na	Na	Na
Command	B0h							

**Device register-**

DEV shall specify the selected device.

**Table 12: SMART command for normal outputs information**

Register	7	6	5	4	3	2	1	0
Error	Na							
Sector Count	Na							
LBA Low	Na							
LBA Mid	Na							
LBA High	Na							
Device	Obs	Na	obs	DEV	Na	Na	Na	Na
Status	BSY	DRDY	DF	Na	DRQ	Na	Na	ERR

**Device Register-**

DEV shall indicate the selected device.

Status register-

BSY will be cleared to zero indicating command completion.

DRDY will be set to one. SMART enabled.

DF (Device Fault) will be cleared to zero.

DRQ shall be cleared to zero.

ERR shall be cleared to zero.

**Table 13: ID of SMART data structure**

<b>ID(Hex)</b>	<b>Description</b>
E9	ECC Fail Record
EA	Average Erase Count, Max Erase Count
EB	Good Block Count, System Block Count

**ID: E9h**

**Table 14: Smart command for ECC fail record information**

<b>Byte</b>	<b>Function</b>	<b>Description</b>
0	ECC fail number	When failure bit is bigger than “ECC Fail number”, this block will be marked as Bad Block.
1	Row address 3	Flash Block Address
2	Row address 2	Flash Block Address
3	Row address 1	Flash Block Address
4	Channel number of last ECC fail	NA
5	Bank number of last ECC fail	NA
6	Reserved	NA
7	Reserved	NA

**ID: EAh**

**Table 15: Smart command for average/max erase count information**

<b>Byte</b>	<b>Function</b>	<b>Description</b>
0	Average Erase Count (High Byte)	Average erase count of all blocks.
1	Average Erase Count	
2	Average Erase Count (Low Byte)	
3	Max Erase Count (High Byte)	Indicate a block which's erase count is the largest.
4	Max Erase Count	
5	Max Erase Count (Low Byte)	
6	Reserved	NA
7	Reserved	NA

*When the Maximum erase count is 255 bigger than average erase count, the wear-leveling will be executed.*

**ID: EBh**

**Table 16: Smart command for good/system block count information**

<b>Byte</b>	<b>Function</b>	<b>Description</b>
0	Good Block Count (High Byte)	Total used blocks of SSD
1	Good Block Count	
2	Good Block Count (Low Byte)	

**Product Specification**

3	System(Free) Block Count (High Byte)	Free block of SSD. Free block has to be bigger than 20. When the free block count is less than 20, the SSD will be locked.
4	System(Free) Block Count (Low Byte)	
5	Reserved	NA
6	Reserved	NA
7	Reserved	NA

**3.4.3.2. S.M.A.R.T. ENABLE OPERATIONS**

**Table 17: SMART Enable command for inputs information**

Register	7	6	5	4	3	2	1	0
Features	D8h							
Sector Count	Na							
LBA Low	Na							
LBA Mid	4Fh							
LBA High	C2h							
Device	Obs	Na	obs	DEV	Na	Na	Na	Na
Command	B0h							

**Device register-**

DEV shall specify the selected device.

**Table 18: SMART command for normal outputs information**

Register	7	6	5	4	3	2	1	0
Error	Na							
Sector Count	Na							
LBA Low	Na							
LBA Mid	Na							
LBA High	Na							
Device	Obs	Na	obs	DEV	Na	Na	Na	Na
Status	BSY	DRDY	DF	Na	DRQ	Na	Na	ERR

**Device Register-**

DEV shall indicate the selected device.

**Status register-**

BSY will be cleared to zero indicating command completion.

DRDY will be set to one.

This command enables access to all SMART capabilities within device.

DF (Device Fault) will be cleared to zero.

DRQ shall be cleared to zero.

ERR shall be cleared to zero.

## 4. Electrical Specification

### 4.1. Device Electrical Characteristics

**Table 19: Absolute Maximum Ratings**

Parameter	Symbol	Condition	Min	Max	Unit
Analog power supply	AV <sub>DDH</sub>		-0.5	6	V
Digital I/O power supply	DV <sub>DD</sub>		-0.5	6	V
Digital I/O input voltage	V <sub>I(D)</sub>		-0.4	DV <sub>DD</sub> +0.4	V
Storage temperature	T <sub>STORAGE</sub>		-55	140	°C

**Table 20: Recommended Power Supply Operation Conditions**

Parameter	Symbol	Condition	Min	Typical	Max	Unit
DC Power Supply	V <sub>DD</sub>		-0.3		+5.5	V
Input voltage	V <sub>IN</sub>		-0.3		+5.5	V
Output voltage	V <sub>OUT</sub>		-0.3		+3.8	V
Operating Temperature	T <sub>A</sub>	Standard	0		+70	°C
		Industrial	-40		+85	°C
Storage Temperature	T <sub>ST</sub>	Standard	-20		+80	°C
		Industrial	-50		+95	°C

## 5. Functional Description

### 5.1. Identify Device Information Default Value

Table 21: Identify Device Table

Word	Value	Description
0	0040h	General Configuration Bit 15: 0=ATA device Bit 14:8: Retired Bit 7:6: Obsolete Bit 5:3: Retired Bit 2: Response incomplete Bit 1: Retired Bit 0 reserved
1	XXXXh	Number of logical cylinders
2	37C8h	Specific configuration
3	16	Number of logical heads
4-5	0000h	Retired
6	63	Number of logical sectors per logical track
7-9	0000h	Retired
10-19	20 ASCII characters	Serial number (ATA String)
20-21	0000h	Retired
22	003Fh	Obsolete
23-26	8 ASCII characters	Firmware revision(ATA String)
27-46	40 ASCII characters	Model number(ATA String)
47	8001h	15-8: 80 7-0: 00h Reserved 01h-FFh: Maximum number of sectors that shall be transferred per DRQ data block on READ/WRITE Multiple commands
48	4000h	Trusted Computing feature set options 15: shall be cleared to zero 14: shall be set to one 13:1: Reserved for the Trusted Computing Group 0: 0 = Trusted Computing feature set is not supported
49	2F00h	Capabilities 15-14: Reserved for the IDENTIFY PACKET DEVICE command. 13: 1=Standby timer values as specified in this standard are supported 0: Standby timer values shall be managed by the device 12: Reserved for the IDENTIFY PACKET DEVICE command 11: 1=IORDY supported 0=IORDY may be disabled 10: 1=IORDY may be disabled 9: 1=LBA supported 8: 1=DMA supported. 7-0: Retired
50	4000h	Capabilities 15: Shall be cleared to zero 14: Shall be set to one 13:2: Reserved 1: Obsolete 0: 0
51	0280h	Obsolete
52	0000h	Obsolete
53	0007h	15: Free-fall control Sensitivity 00h: Vendor's recommended setting 7: 3: Reserved

## Product Specification

Word	Value	Description
		2: 1=the fields reported in word 88 are valid 1: 1=the fields reported in words (70:64) are valid 0: Obsolete
54	XXXXh	Number of current logical cylinders
55	XXXXh	Number of current logical heads
56	XXXXh	Number of current logical sectors per logical track
57-58	XXXXh	Current capacity in sectors
59	0001h	15:9 Reserved 8 0:Multiple sector setting is invalid 7:0 Current setting for number of logical sectors that shall be transferred per DRQ data block on READ/WRITE Multi commands
60-61	XXXXXXXXh	Total number of user address sectors(DWord)
62	0000h	Obsolete
63	0007h	Multi-word DMA transfer(Not support)
64	0003h	15-8 Reserved 7-0 PIO modes supported
65	0078h	Minimum Multiword DMA transfer cycle time per word 15-0 Cycle time in nanoseconds
66	0078h	Manufacturer's recommended Multiword DMA transfer cycle time per word 15-0 Cycle time in nanoseconds
67	0078h	Minimum PIO transfer cycle time without flow control 15-0 Cycle time in nanoseconds
68	0078h	Minimum PIO transfer cycle time with IORDY flow control 15-0 Cycle time in nanoseconds
69-74	0000h	Reserved
75	0000h	No DMA QUEUED command supports
76	0606h	Serial ATA Capabilities 15:11 Reserved for Serial ATA 10 1= Supports Phy Event Counters 9 1= Supports receipt of host initiated power management Requests 8 0= No Support native Command Queuing 7:3 Reserved for future SATA signaling speed grades 2 1=Supports SATA Gen2 Signaling Speed (3.0Gb/s) 1 1=Support SATA Gen1 Signaling Speed (1.5Gb/s) 0 Shall be cleared to zero
77	0000h	Reserved for Serial ATA
78	0000h	Serial ATA features supported 15:7 Reserved for Serial ATA 6 0=Device not supports Software Settings Preservation 5 Reserved for Serial ATA 4 0= Device not supports in-order data delivery 3 0= Device not supports initiating power management 2 0= Device not supports DMA Setup auto-activation 1 0= Device not supports non-zero buffer offsets 0 Shall be cleared to zero
79	0000h	Serial ATA feature enabled 15:7 Reserved for Serial ATA 6 0=Software Settings Preservation not enabled 5 0=Reserved for Serial ATA 4 0= In-order data delivery not enabled 3 0= Device initiated power management not enabled 2 0= DMA setup auto-activation not enabled 1 0= Non-zero buffer offsets not enabled 0 Shall be cleared to zero
80-81	01FE 0021h	ATA Version support (ATA8-ACS )
82	0069h	Command and feature sets supported

**Product Specification**

<b>Word</b>	<b>Value</b>	<b>Description</b>
		15 0 = Obsolete 14 0 = NOP Command not supported 13 0 = READ BUFFER Command not supported 12 0 = WRITE BUFFER Command not supported 11 0 = Obsolete 10 0 = Host Protected Area Feature Set not supported 9 0 = DEVICE RESET Command not supported 8 0 = SERVICE Interrupt not supported 7 0 = RELEASE Interrupt not supported 6 1 = Look-ahead supported 5 1 = Write Cache supported 4 0 = indicate that the PACKET feature set is not supported 3 1 = mandatory Power Management Feature Set supported 2 0 = Obsolete 1 0 = Security Mode Feature Set not supported 0 1 = SMART Feature Set supported
<b>83</b>	5000h	Command and feature sets supported 15 Shall be cleared to zero 14 Shall be set to one 13 0 = FLUSH CACHE EXT Command not supported 12 1 = mandatory FLUSH CACHE Command supported 11 0 = Device Configuration Overlay feature set not supported 10 0 = 48-Bit Address feature set not supported 9 0 = Automatic Acoustic Management feature set not supported 8 0 = SET MAX security extension not supported 7 0 = See Address Offset Reserved Area Boot, INCITS TR27:2001 6 0 = SET FEATURES subcommand not required to spin-up after power-up 5 0 = Power-Up in Standby feature set supported 4 0 = Removable Media Status Notification feature set not supported 3 0 = Advanced Power Management feature set not supported 2 0 = CFA feature set not supported 1 0 = READ/WRITE DMA QUEUED not supported 0 1 = DOWNLOAD MICROCODE Command supported
<b>84</b>	4000h	Command Set/Feature Supported Extension 15 Shall be cleared to zero 14 Shall be set to one 13-6 Reserved 5 0 = General Purpose Logging feature set not supported 4 Reserved 3 0 = Media Card Pass Through Command feature set not supported 2 0 = Media Serial Number not supported 1 0 = SMART self-test not supported 0 1 = SMART Error Logging not supported
<b>85</b>	0008	Command and feature sets supported or enabled 15 0 = Obsolete 14 0 = NOP Command not enabled 13 0 = READ BUFFER Command not enabled 12 0 = WRITE BUFFER Command not enabled 11 Obsolete 10 0 = Host Protected Area feature set not enabled 9 0 = DEVICE RESET Command not enabled 8 0 = SERVICE Interrupt not enabled 7 0 = RELEASE Interrupt not enabled 6 0 = Look-ahead not enabled 5 0 = Write Cache not enabled 4 Shall be cleared to zero to indicate that the PACKET Command feature set is not supported. 3 1 = Power Management Feature Set enabled

Word	Value	Description
		2 0 = Removable Media feature set not enabled 1 0 = Security Mode Feature Set not enabled 0 0 = SMART Feature Set not enabled
86	5000h	Command set/feature enabled 15-14 0 = Reserved 13 0 = FLUSH CACHE EXT Command not supported 12 1 = FLUSH CACHE Command supported 11 0 = Device Configuration Overlay not supported 10 0 = 48-Bit Address features set not supported 9 0 = Automatic Acoustic Management feature set not enabled 8 0 = SET MAX security extension not enabled by SET MAX SETPASSWORD 7 0 = Reserved 6 0 = SET FEATURES subcommand required to spin-up after power-up not enabled 5 0 = Power-Up in Standby feature set not enabled 4 0 = Obsolete 3 1 = Advanced Power Management feature set enabled 2 0 = CFA feature set not supported 1 0 = READ/WRITE DMA QUEUED Command not supported 0 1 = DOWNLOAD MICROCODE Command supported
87	4000h	Command and feature sets supported or enabled 15 Shall be cleared to zero 14 Shall be set to one 13 1 = IDLE IMMEDIATE with UNLOAD FEATURE supported 12 0 = Reserved for Technical Report, INCITS TR-37-2004 11 0 = Reserved for Technical Report, INCITS TR-37-2004 10:9 0 = Obsolete 8 0 = 64-Bit World Wide Name not supported 7 0 = WRITE DMA QUEUED FUA EXT Command not supported 6 0 = WRITE DMA FUA EXT and WRITE MULTIPLE FUA EXT commands not supported 5 0 = General Purpose Logging feature set not supported 4 0 = Obsolete 3 0 = Media Card Pass Through Command feature set not supported 2 0 = Media Serial Number is not valid 1 0 = SMART Self-Test not supported 0 0 = SMART Error-Logging not supported
88	X03Fh	Ultra DMA modes 15 Reserved 14 0 = Ultra DMA mode 6 is not supported 13 1 = Ultra DMA mode 5 is selected 0 = Ultra DMA mode 5 is not selected 12 1 = Ultra DMA mode 4 is selected 0 = Ultra DMA mode 4 is not selected 11 1 = Ultra DMA mode 3 is selected 0 = Ultra DMA mode 3 is not selected 10 1 = Ultra DMA mode 2 is selected 0 = Ultra DMA mode 2 is not selected 9 1 = Ultra DMA mode 1 is selected 0 = Ultra DMA mode 1 is not selected 8 1 = Ultra DMA mode 0 is selected 0 = Ultra DMA mode 0 is not selected 7 Reserved 6 0 = Ultra DMA mode 6 is not supported 5 1 = Ultra DMA mode 5 and below are supported 4 1 = Ultra DMA mode 4 and below are supported 3 1 = Ultra DMA mode 3 and below are supported 2 1 = Ultra DMA mode 2 and below are supported 1 1 = Ultra DMA mode 1 and below are supported 0 1 = Ultra DMA mode 0 is supported
89	0000h	Time required for Normal Erase mode SECURITY ERASE UNIT command
90	0000h	Time required for Enhanced erase mode SECURITY ERASE UNIT command
91	0000h	Current advanced power management level value

**Product Specification**

<b>Word</b>	<b>Value</b>	<b>Description</b>
<b>92</b>	0000h	Master Password Identifier
<b>93</b>	XXXXh	Hardware reset result
<b>94</b>	80FEh	Current automatic acoustic management value 15:8 Vendor's recommended acoustic management value. 7:0 Current automatic acoustic management value.
<b>95-126</b>	0000h	Reserved
<b>127</b>	0000h	Obsolete
<b>128</b>	0000h	Security Status 15:9 Reserved 8 Security level 0 = high, 1 = Maximum 7:6 Reserved 5 1= Enhanced security erase supported 4 1= Security count expired 3 0= Security frozen. 2 0 = Security not locked 1 0= Security not enabled 0 0= Security not supported
<b>129-158</b>	0000h	Vendor specific
<b>159</b>	0x81	Secure Erase based on NSA Manual 130-2
	0x41	Secure Erase based on USA-AF AFSSI 5020
	0x84	Secure Erase based on DoD 5220.22-M
	0XD0	Secure Erase based on IREC (IRIG) 106
<b>160</b>	0000h	CFA power mode 1(Not support)
<b>161-175</b>	0000h	Reserved
<b>176-205</b>	0000h	Current media serial number
<b>206-254</b>	0000h	Reserved
<b>255</b>	XXXXh	Integrity word 15:8 Check Sum 7:0 Signature

## 6. Procedure of Fast Erase / Secure Erase

Fast Erase procedure is the basic and quicker Secure Erase procedures on SSD. The APRO Rugged Metal 2.5" SATA MLC SSD's Fast Erase function is activated via the Sanitize hardware interrupt triggered by additional two pins ( J1 / Pin-1 & Pin-2) on PCB (Printed Circuit Board) as jumper setting as being shorted.

### 6.1 2.5" SATA SSD \_BON Series Fast Erase Introduction

- Fast Erase Procedure is one of Default Sanitize Procedure in APRO Secure Erase SSD Series.
- (J1) Pin-1 & Pin-2 on PCB is defined as Fast Erase/Secure Erase Function Pin.
- To initiate Fast Erase Procedure, shorten (J1) Pin-1 & Pin-2 or insert pin hat on (J1) Pin-1 & Pin-2 when power is on and fast erase will not stop until procedure completed or power is off.
- When SSD is power-on, shortening (J1) Pin-1 & Pin-2 triggers controller firmware to program all flash blocks into 0xFF.
- 8GB SSD needs about 6 seconds, and 128GB needs about 60 seconds to run the fast erase procedure for whole disk completely.

### 6.2 Executing Sanitize procedure during power interruption

- After power interruption, Fast Erase/Secure Erase Procedure stops; when power is restored and (J1) Pin-1 & Pin-2 Jumper hat is not removed, Fast Erase Procedure keeps completing the procedure.
- When power is on, partition constructions by MBR (LBA-0 to LBA-X) will be destroyed immediately as "Fast Erase" is executed. Thus, no matter the power is interrupted or not, partition constructions are destroyed. To use the SSD again, partitions need to be executed low-level format again.

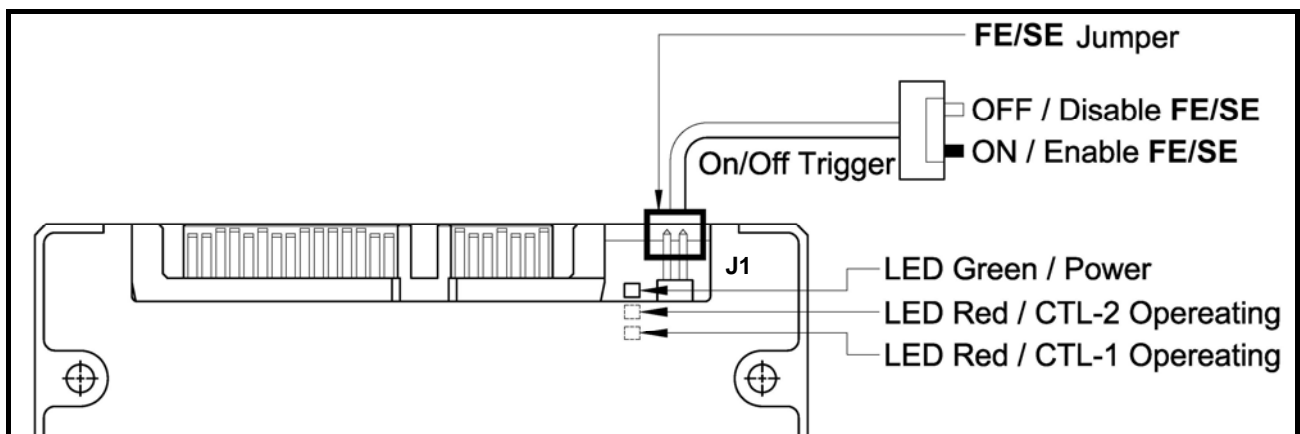



Figure 6: Secure Erase/Fast Erase Jumper Setting

**Appendix A. Ordering Information**

*(1) Part Number List*

◆ **BON Series Rugged Metal 2.5" SATA MLC SSD supports FE/SE**

Product Picture	Capacity	Standard grade ( 0°C ~ 70°C )	Industrial grade (-40°C ~ +85°C)
	<b>8GB</b>	SR2SF008G-JACMC-UFE(USE)	WR2SF008G-JACMC-UFE(USE)C
	<b>16GB</b>	SR2SF016G-JACMC-UFE(USE)	WR2SF016G-JACMC-UFE(USE)C
	<b>32GB</b>	SR2SF032G-JACMC-UFE(USE)	WR2SF032G-JACMC-UFE(USE)C
	<b>64GB</b>	SR2SF064G-JACMC-UFE(USE)	WR2SF064G-JACMC-UFE(USE)C
	<b>128GB</b>	SR2SF128G-JACMC-UFE(USE)	WR2SF128G-JACMC-UFE(USE)C
	<b>256GB</b>	SR2SF256G-JACMC-UFE(USE)	WR2SF256G-JACMC-UFE(USE)C

**Notes:**

1. **UFE** : Fast Erase function
2. **USE** : Secure Erase function (supported by special firmware) & Fast Erase function
3. **C** : Special conformal coating treated on whole PCBA which may support industrial grade operating temperature -40°C ~ +85°C

(2) Part Number Decoder

**X1 X2 X3 X4 X5 X6 X7 X8 X9** — **X11 X12 X13 X14 X15** — **X17 X18 X19** **C**

**X1** : Grade

**S**: Standard Grade – operating temp. 0° C ~ 70 ° C  
**W**: Industrial Grade – operating temp. -40° C ~ +85 ° C

**X2** : The material of case

**R** : 2.5" Rugged Metal Casing

**X3 X4 X5** : Product category

**2SF** : 2.5" SATA SSD

**X6 X7 X8 X9** : Capacity

<b>008G</b> : 8GB	<b>128G</b> : 128GB
<b>016G</b> : 16GB	<b>256G</b> : 256GB
<b>032G</b> : 32GB	
<b>064G</b> : 64GB	

**X11** : Controller

**J** : JMicron (BON Series supports Fast Erase and Secure Erase procedures)

**X12** : Controller version

**A, B, C.....**

**X13** : Controller Grade

**C** : Commercial grade

**X14** : Flash IC

**M** : MLC-NAND Flash IC

**X15** : Flash IC grade / Type

**C** : Commercial grade

**X17 X18 X19** : Special function

**UFE** : Fast Erase function only

**USE**: Secure Erase function (supported by special firmware) & Fast Erase function

**C** : Reserved for specific requirement

**C** : Conformal-coating or reserved for special request by the customer

**Appendix B. Limited Warranty**

APRO warrants your Rugged Metal 2.5" SATA MLC SSD against defects in material and workmanship for the life of the drive. The warranty is void in the case of misuse, accident, alteration, improper installation, misapplication or the result of unauthorized service or repair. The implied warranties of merchantability and fitness for a particular purpose, and all other warranties, expressed or implied, except as set forth in this warranty, shall not apply to the products delivered. In no event shall APRO be liable for any lost profits, lost savings or other incidental or consequential damages arising out of the use of, or inability to use, this product.

**BEFORE RETURNING PRODUCT, A RETURN MATERIAL AUTHORIZATION (RMA) MUST BE OBTAINED FROM APRO.**

Product shall be returned to APRO with shipping prepaid. If the product fails to conform based on customers' purchasing orders, APRO will reimburse customers for the transportation charges incurred.

**Warranty Period:**

- SR2SFXXXG-JACMC-UFE(USE)                      1 year
- WR2SFXXXG-JACMC-UFE(USE)C                      1 year



***The warranty period is able to extend. Please contact with APRO or Your APRO distributor for more information.***